

FEATURES

- ☞ Fast switching
- ☞ 100% avalanche tested
- ☞ Improved dv/dt capability

APPLICATIONS

- ☞ Switch Mode Power Supply (SMPS)
- ☞ Uninterruptible Power Supply (UPS)
- ☞ Power Factor Correction (PFC)

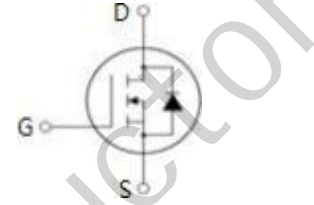
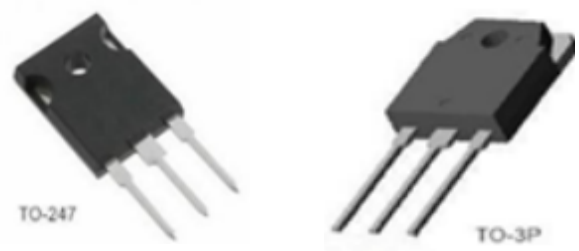

Device Marking and Package Information		
Device	Package	Marking
JSM90N20P	TO-3P	JSM90N20P
JSM90N20P	TO-247	JSM90N20P

Absolute Maximum Ratings $T_C = 25^\circ\text{C}$, unless otherwise noted				
Parameter	Symbol	Value		Unit
		TO-3P	TO-247	
Drain-Source Voltage ($V_{GS} = 0\text{V}$)	V_{DSS}	220		V
Continuous Drain Current $V_{GS} = 10\text{V}$ $T_C = 25^\circ\text{C}$	I_b	80		A
Pulsed Drain Current (note1)	I_{DM}	320		A
Gate-Source Voltage	V_{GSS}	± 20		V
Single Pulse Avalanche Energy (note2)	E_{AS}	1960.2		mJ
Avalanche Current (note1)	I_{AS}	19.8		A
Repetitive Avalanche Energy (note1)	E_{AR}	1176.1		mJ
Power Dissipation ($T_C = 25^\circ\text{C}$)	P_D	140		W
Peak Diode Recovery dv/dt (note1)	dv/dt	5.0		
Operating Junction and Storage Temperature Range	T_J, T_{stg}	-55~+150		$^\circ\text{C}$

Thermal Resistance			
Parameter	Symbol	Value	Unit
Thermal Resistance, Junction-to-Case	R_{thJC}	0.89	$^\circ\text{C/W}$
Thermal Resistance, Junction-to-Ambient	R_{thJA}	60	

Specifications $T_J = 25^\circ\text{C}$, unless otherwise noted						
Parameter	Symbol	Test Conditions	Value			Unit
			Min.	Typ.	Max.	
Static						
Drain-Source Breakdown Voltage	$V_{(BR)DSS}$	$V_{GS} = 0V, I_D = 250\mu A$	220	--	--	V
Zero Gate Voltage Drain Current	I_{DSS}	$V_{DS} = 40V, V_{GS} = 0V, T_J = 25^\circ\text{C}$	--	--	1	μA
		$V_{DS} = 32V, V_{GS} = 0V, T_J = 125^\circ\text{C}$	--	--	100	
Gate-Source Leakage	I_{GSS}	$V_{GS} = \pm 20V$	--	--	± 100	nA
Gate-Source Threshold Voltage	$V_{GS(th)}$	$V_{DS} = V_{GS}, I_D = 250\mu A$	2.0	--	4.0	V
Drain-Source On-Resistance (Note3)	$R_{DS(on)}$	$V_{GS} = 10V, I_D = 95A(\text{Note4})$	--	30	35	$m\Omega$
Dynamic						
Input Capacitance	C_{iss}	$V_{GS} = 0V,$ $V_{DS} = 25V,$ $f = 1.0\text{MHz}$	--	5784	--	pF
Output Capacitance	C_{oss}		--	893	--	
Reverse Transfer Capacitance	C_{rss}		--	561	--	
Total Gate Charge	Q_g	$V_{DD} 20V, I_D = 190A,$ $V_{GS} = 10V(\text{Note4})$	--	367	--	nC
Gate-Source Charge	Q_{gs}		--	33.8	--	
Gate-Drain Charge	Q_{gd}		--	177	--	
Turn-on Delay Time	$t_{d(on)}$	$V_{DD} = 20V, I_D = 190A,$ $R_G = 10\Omega, V_{GS} = 10V$ (Note4)	--	55	--	ns
Turn-on Rise Time	t_r		--	165	--	
Turn-off Delay Time	$t_{d(off)}$		--	1050	--	
Turn-off Fall Time	t_f		--	367	--	
Drain-Source Body Diode Characteristics						
Continuous Body Diode Current	I_S	$T_C = 25^\circ\text{C}$	--	--	80	A
Pulsed Diode Forward Current	I_{SM}		--	--	320	
Body Diode Voltage	V_{SD}	$T_J = 25^\circ\text{C}, I_{SD} = 95A, V_{GS} = 0V$	--	--	1.4	V
Reverse Recovery Time	t_{rr}	$V_{GS} = 0V, I_S = 190A,$ $di_f/dt = 100A/\mu s$	--	360	--	ns
Reverse Recovery Charge	Q_{rr}		--	5.61	--	μC

Notes

1. Repetitive Rating: Pulse width limited by maximum junction temperature
2. $L = 10\text{mH}, V_{DD} = 50V, R_G = 25\Omega, \text{Starting } T_J = 25^\circ\text{C}$
3. Pulse Test: Pulse width $\leq 300\mu s, \text{Duty Cycle} \leq 1\%$

Typical Characteristics $T_J = 25^\circ\text{C}$, unless otherwise noted

Figure 1. Output Characteristics ($T_J = 25^\circ\text{C}$)

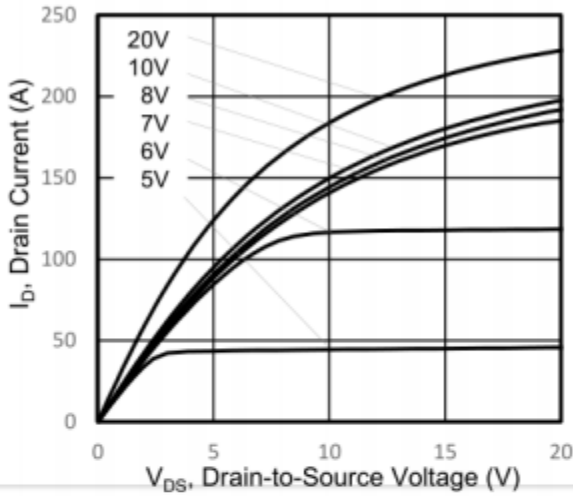

Figure 2. Body Diode Forward Voltage

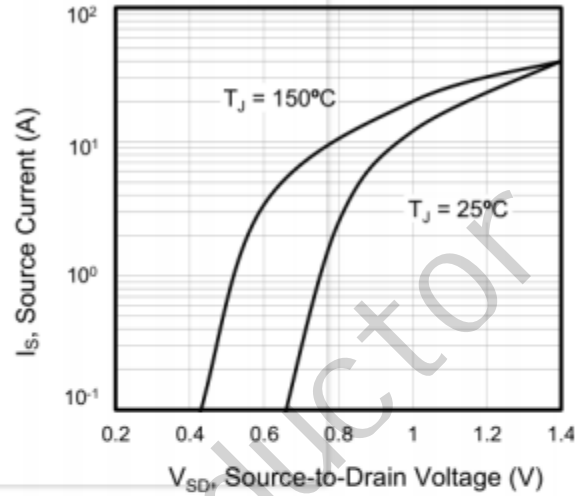

Figure 3. Drain Current vs. Temperature

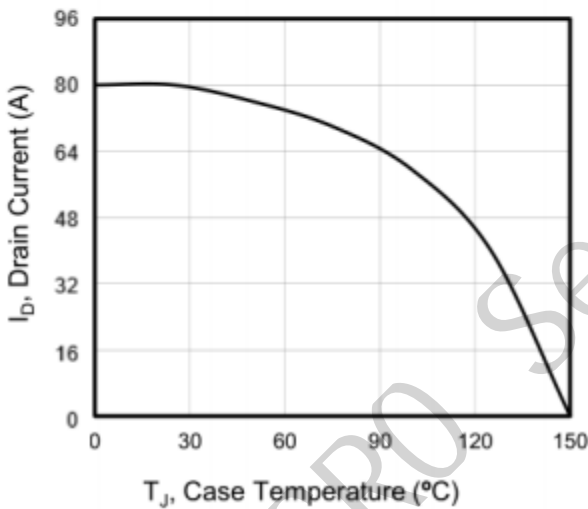

Figure 4. BV_{DSS} Variation vs. Temperature

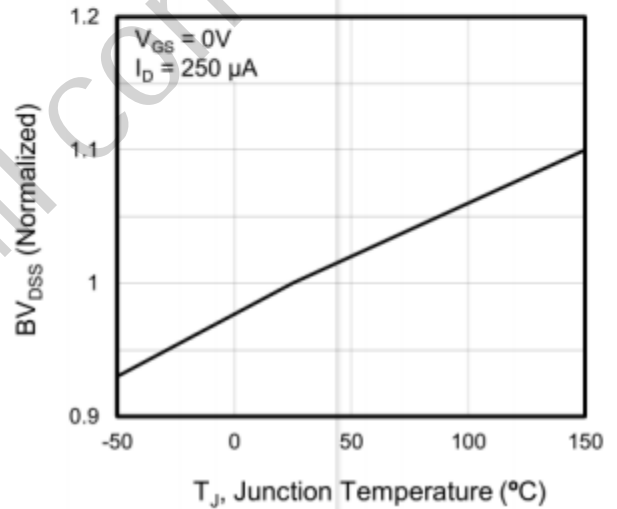

Figure 5. Transfer Characteristics

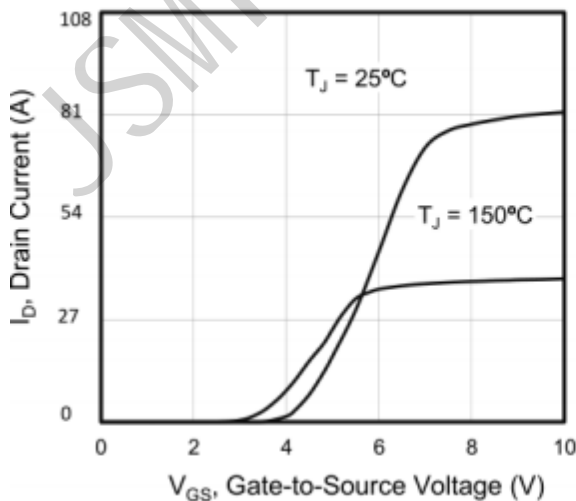
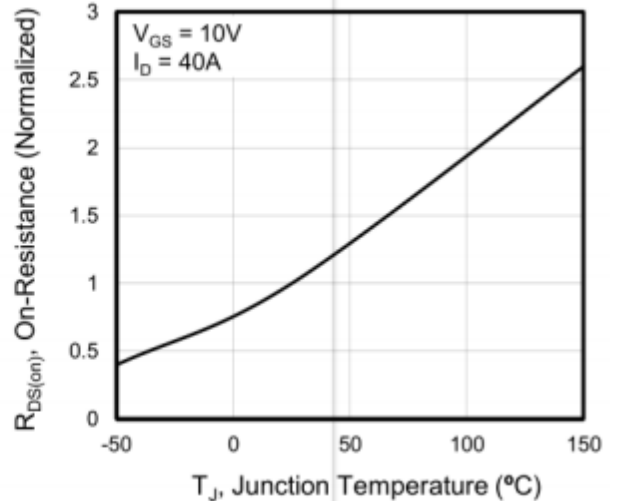

Figure 6. On-Resistance vs. Temperature



Typical Characteristics $T_J = 25^\circ\text{C}$, unless otherwise noted

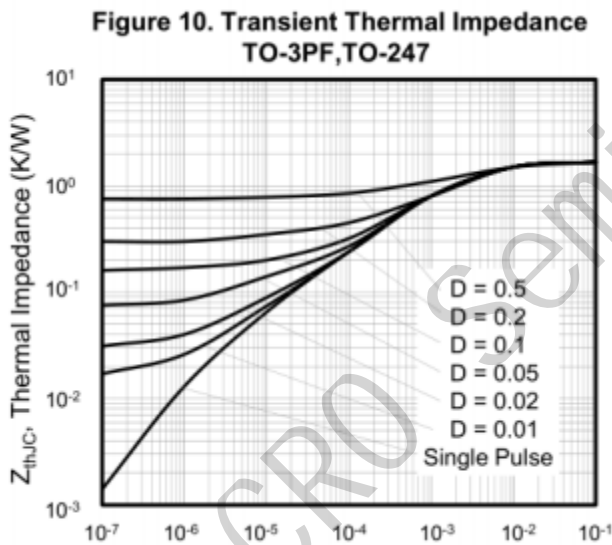
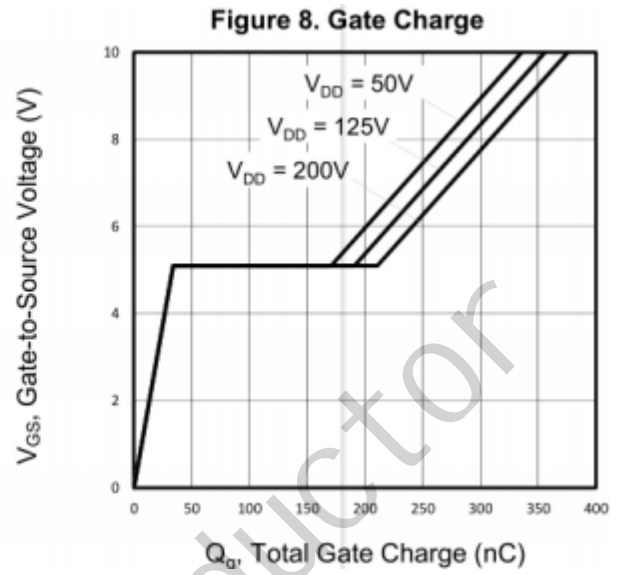
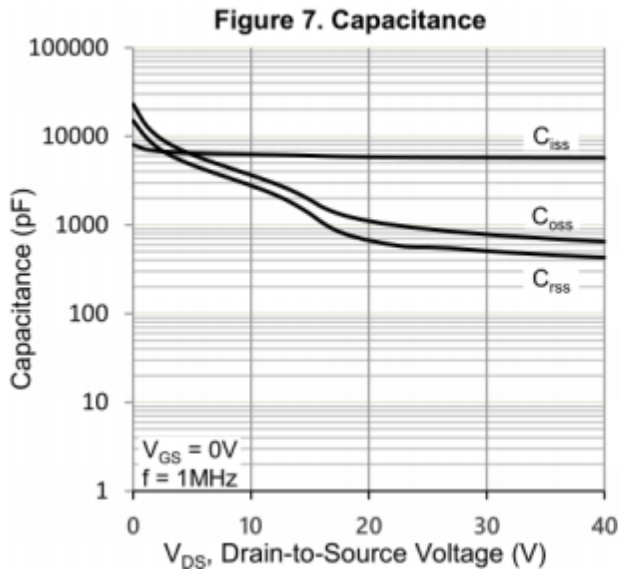

Figure A: Gate Charge Test Circuit and Waveform

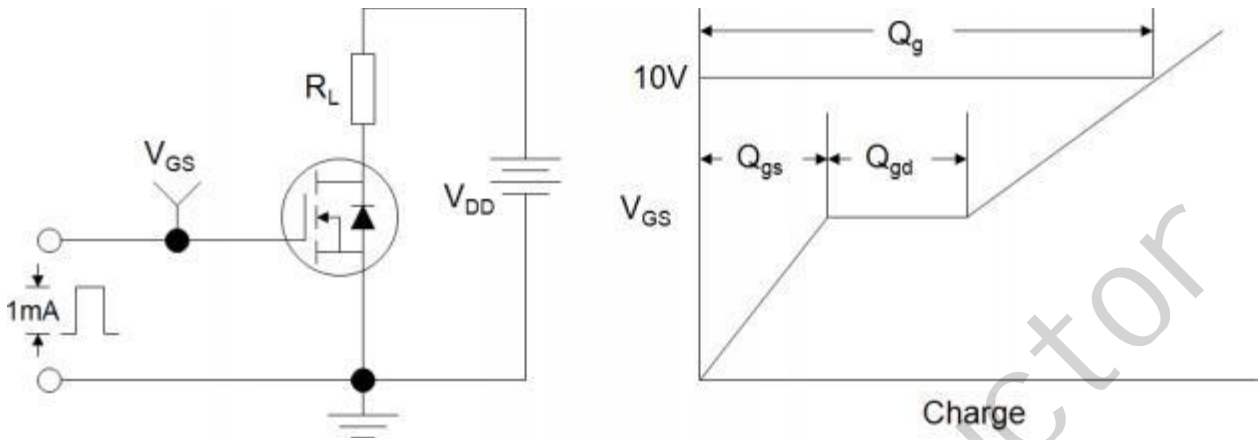

Figure B : Resistive Switching Test Circuit and Waveform

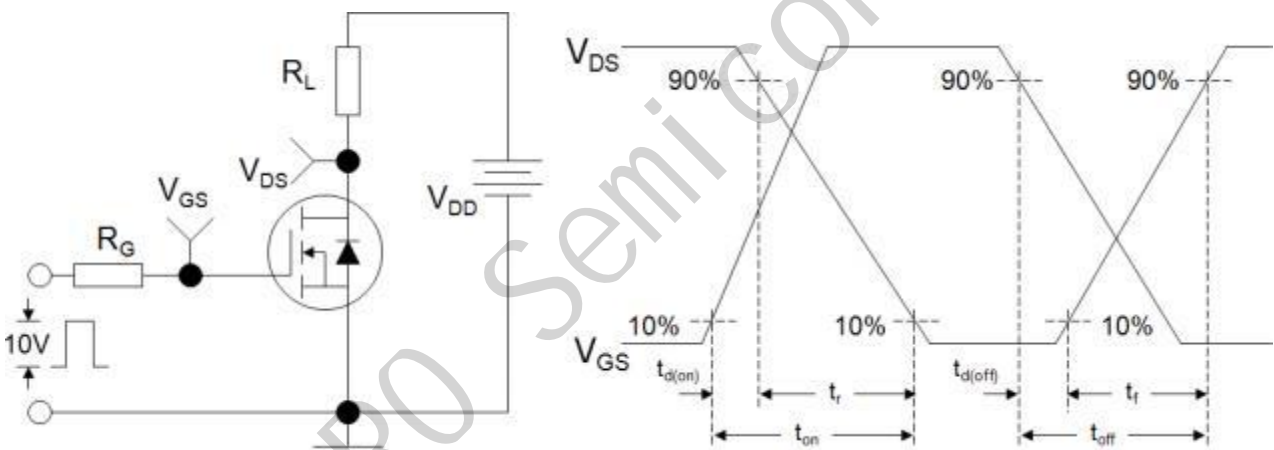
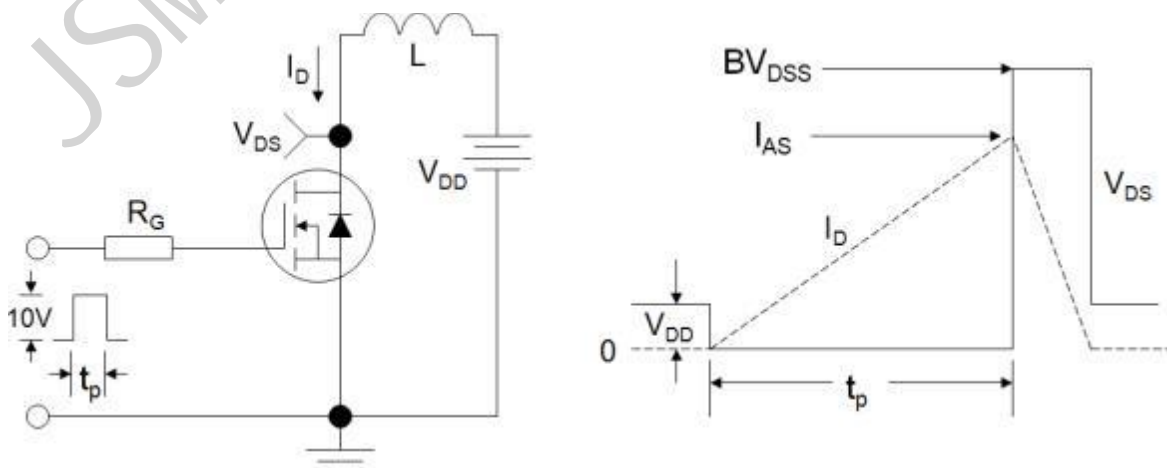

Figure C : Unclamped Inductive Switching Test Circuit and Waveform



TO-247 Package Dimensions

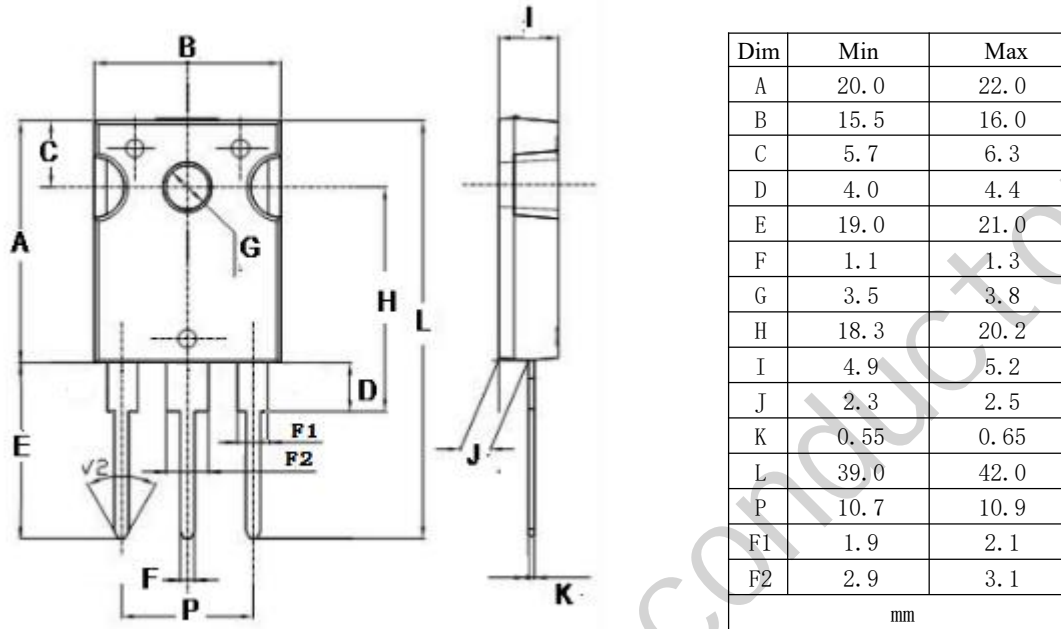
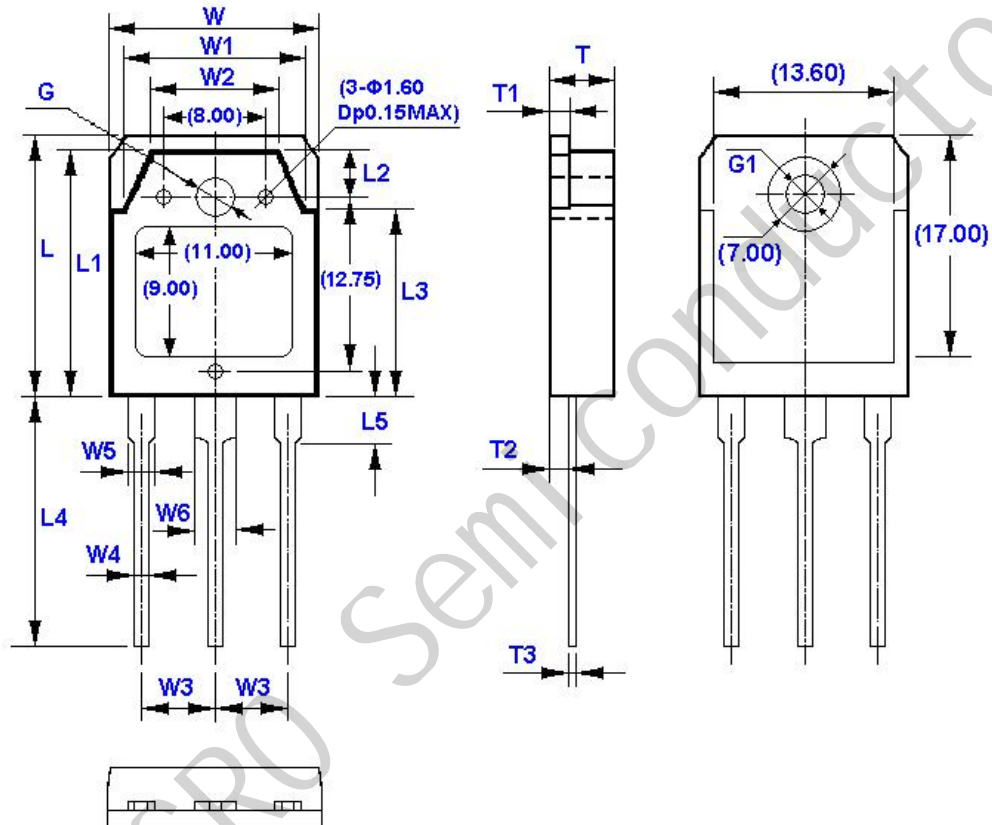

Fig.2 outline dimensions (unindicated tolerance:±0.1mm)

TO-3P

Unit: mm



Symbol	Size		Symbol	Size		Symbol	Size		Symbol	Size	
	Min	Max		Min	Max		Min	Max		Min	Max
W	15.40	15.80	W5	1.80	2.20	L3	13.70	14.10	T2	1.20	1.60
W1	13.40	13.80	W6	2.80	3.20	L4	19.70	20.30	T3	0.55	0.75
W2	9.40	9.80	L	19.70	20.10	L5	3.30	3.70	G (Φ) (Front)	3.30	3.50
W3	5.45 (TYP)		L1	18.50	18.90	T	4.60	5.00	G1(Φ) (Back)	3.10	3.30
W4	0.80	1.20	L2	3.60	4.00	T1	1.45	1.65			